

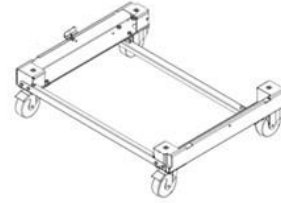

Mobile Undercarriage for RATIONAL combi ovens.

Mobile undercarriage for models 61/101 and 62/102

This mobile undercarriage accessory allows for flexibility when designing a RATIONAL into different locations within a kitchen e.g. kitchen suites, under counters, under other equipment. Proper clearance and venting is still required. See designer manual for more information.



Item numbers

Undercarriage for model 61/101

N°: 60.60.968

Undercarriage for model 62/102

N°: 60.60.513

Currently we do not have a complete drawing.

The height to top of a 6 pan unit is $33 \frac{3}{4}$ " plus 2" for the steam vent. **For a total of $35 \frac{3}{4}$ "**

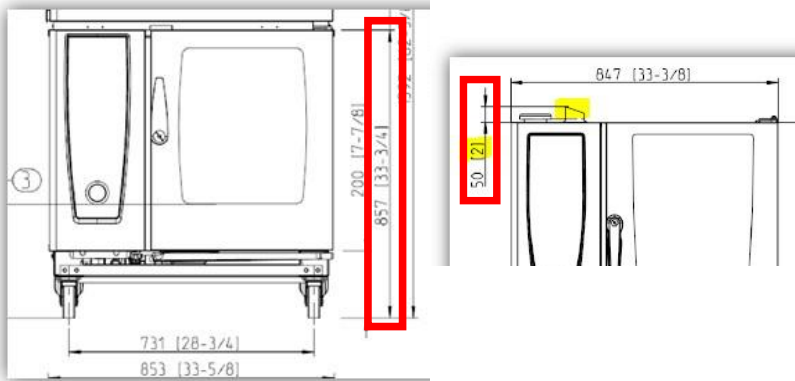

The drain (5) is at $6 \frac{1}{4}$ " height and should discharge into a floor sink with a 1" air gap. The drain needs to handle high temperature water and handle short-term bursts of 0.17 g/sec.

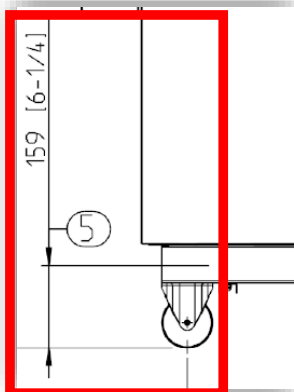

Flexible connections of water, electrical and gas need to be used so the devices can be pulled out for service.

2" clearance is recommended on the left, right and rear of the units.

Next consideration is the vent pipes through the work surface.

For electric units, there is one steam vent pipe(7).

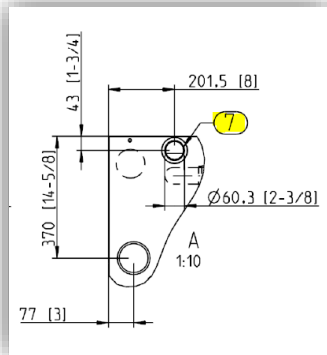

Top View 61 Electric.

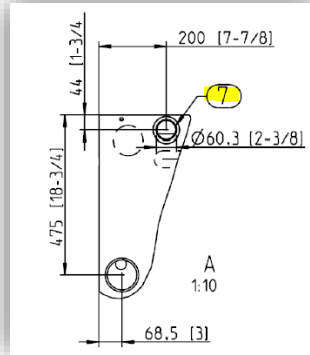

Top View 62 Electric.

1. Common water supply (cold water) "Single" water connection as shipped 2. Water supply cold water / condensate "Split" water connection 3. Water supply cold / Treated "Split" water connection 4. Drain 2" OD 5. Electrical connection wire entrance 6. Chassis Ground connection 7. **Steam Vent pipe DN 2 3/8" / 60mm** 8. Splashwater-proof Ethernet socket RJ45; Minimum Clearance 2" / 50 mm Left side clearance 20" recommended for servicing of unit without the ability to move unit while connected. Measurements in mm (inch)

For gas units, there is one steam vent (7) and two gas flue exhausts (9 & 10). Gas flue exhaust temperature can reach 1,000°F. Custom protection must be considered.

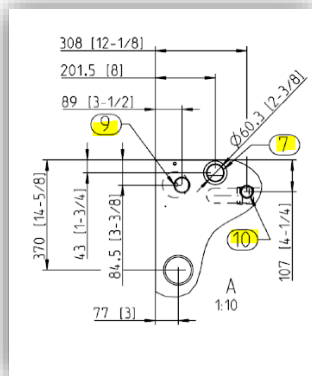

Top View 61 Gas.

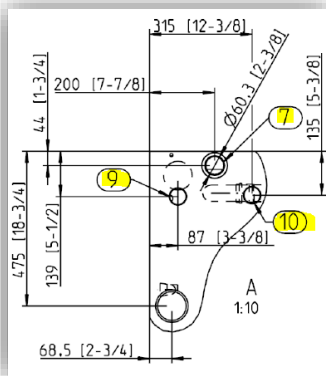

Top view 62 Gas.

1. Common water supply (cold water) "Single" water connection as shipped 2. Water supply cold water / condensate "Split" water connection 3. Water supply cold / Treated "Split" water connection 4. Water drain 5. Electrical connection wire entrance 6. Chassis Ground connection 7. **Steam Vent pipe DN 2 3/8" / 60 mm** 8. Gas connection 3/4 NPT 9. **Steam burner exhaust pipe** 10. **Hot-air burner exhaust pipe** minimum distance 2" / 50 mm Left side clearance 20" recommended for servicing of unit without the ability to move unit while connected. Measurements in mm (inch)